

# GUNDAM

RISE FROM THE ASHES

# SIDE STORY 0079



SEGA®

**BAN  
DAI**

**TEEN**  
®  
**T**  
CONTENT RATED BY  
**ESRB**

T-13301N

# **WARNINGS Read Before Using Your Sega Dreamcast Video Game System**

## **CAUTION**

Anyone who uses the Sega Dreamcast should read the operating manual for the software and console before operating them. A responsible adult should read these manuals together with any minors who will use the Sega Dreamcast before the minor uses it.

## **HEALTH AND EPILEPSY WARNING**

Some small number of people are susceptible to epileptic seizures or loss of consciousness when exposed to certain flashing lights or light patterns that they encounter in everyday life, such as those in certain television images or video games. These seizures or loss of consciousness may occur even if the person has never had an epileptic seizure.

If you or anyone in your family has ever had symptoms related to epilepsy when exposed to flashing lights, consult your doctor prior to using Sega Dreamcast.

In all cases, parents should monitor the use of video games by their children. If any player experiences dizziness, blurred vision, eye or muscle twitches, loss of consciousness, disorientation, any involuntary movement or convulsion, **IMMEDIATELY DISCONTINUE USE AND CONSULT YOUR DOCTOR BEFORE RESUMING PLAY.**

To reduce the possibility of such symptoms, the operator must follow these safety precautions at all times when using Sega Dreamcast:

- Sit a minimum of 6.5 feet away from the television screen. This should be as far as the length of the controller cable.
- Do not play if you are tired or have not had much sleep.
- Make sure that the room in which you are playing has all the lights on and is well lit.
- Stop playing video games for at least ten to twenty minutes per hour. This will rest your eyes, neck, arms and fingers so that you can continue comfortably playing the game in the future.

## **OPERATING PRECAUTIONS**

To prevent personal injury, property damage or malfunction:

- Before removing disc, be sure it has stopped spinning.
- The Sega Dreamcast GD-ROM disc is intended for use exclusively on the Sega Dreamcast video game system. Do not use this disc in anything other than a Sega Dreamcast console, especially not in a CD player.
- Do not allow fingerprints or dirt on either side of the disc.
- Avoid bending the disc. Do not touch, smudge or scratch its surface.
- Do not modify or enlarge the center hole of the disc or use a disc that is cracked, modified or repaired with adhesive tape.
- Do not write on or apply anything to either side of the disc.
- Store the disc in its original case and do not expose it to high temperature and humidity.
- Do not leave the disc in direct sunlight or near a radiator or other source of heat.
- Use lens cleaner and a soft dry cloth to clean disc, wiping gently from the center to the edge. Never use chemicals such as benzene and paint thinner to clean disc.

## **PROJECTION TELEVISION WARNING**

Still pictures or images may cause permanent picture tube damage or mark the phosphor of the CRT. Avoid repeated or extended use of video games on large-screen projection televisions.

## **SEGA DREAMCAST VIDEO GAME USE**

This GD-ROM can only be used with the Sega Dreamcast video game system. Do not attempt to play this GD-ROM on any other CD player; doing so may damage the headphones and/or speakers. This game is licensed for home play on the Sega Dreamcast video game system only. Unauthorized copying, reproduction, rental, public performance of this game is a violation of applicable laws. The characters and events portrayed in this game are purely fictional. Any similarity to other persons, living or dead, is purely coincidental.

# GUNDAM

RISE FROM THE ASHES

## SIDE STORY 0079

### CONTENTS

<b>STORY</b>	<b>P02</b>	<b>COMMAND</b>	<b>P16</b>
<b>CHARACTER</b>	<b>P04</b>	<b>GAME OVER</b>	<b>P18</b>
<b>START GAME</b>	<b>P06</b>	<b>SYSTEM</b>	<b>P18</b>
<b>BRIEFING</b>	<b>P08</b>	<b>OPTION</b>	<b>P19</b>
<b>MAIN FRAME</b>	<b>P10</b>	<b>MOBILE SUIT</b>	<b>P20</b>
<b>TACTICS</b>	<b>P15</b>	<b>TECHNIQUE</b>	<b>P22</b>

# STORY

January, UC 0079.

The space colony Side 3 declares itself the Duchy of Zeon and begins a war of independence against the Earth Federation government. As hostilities commence, the Zeon Army carries out Operation British, dropping a space colony on Earth. Its target is Jabrow, the Earth Federation Army's stronghold in South America.

Due to desperate resistance by the Earth Federation Army, the colony disintegrates in the skies over Saudi Arabia after it enters the Earth's atmosphere. The drop onto Jabrow is prevented, but the leading edge of the enormous colony falls on Sidney Australia, transforming the city into an enormous bay.

The Zeon Army, which doesn't have the resources to sustain a protracted conflict because it is a space colony state, anticipates a lengthening of the war after the failure of Operation British. They immediately begin a series of Drop Operations to secure resources, and rapidly occupy 2/3 of the Earth's surface.

The Zeon Army invades Australia, hardest hit by Operation British, in order to secure its abundant subterranean resources. The Federation Army in Australia, having suffered a crushing blow, doesn't appear to stand a chance.

11 months after the beginning of the war, the Earth Federation government launches a massive counteroffensive in Europe called Operation Odessa, and is victorious. Due to the success of Operation Odessa, the military balance on Earth begins to shift significantly in favor of the Federation Army, and counteroffensives commence all over the globe. Even in Australia, still recovering from the devastation of Operation British, a counteroffensive is about to begin...

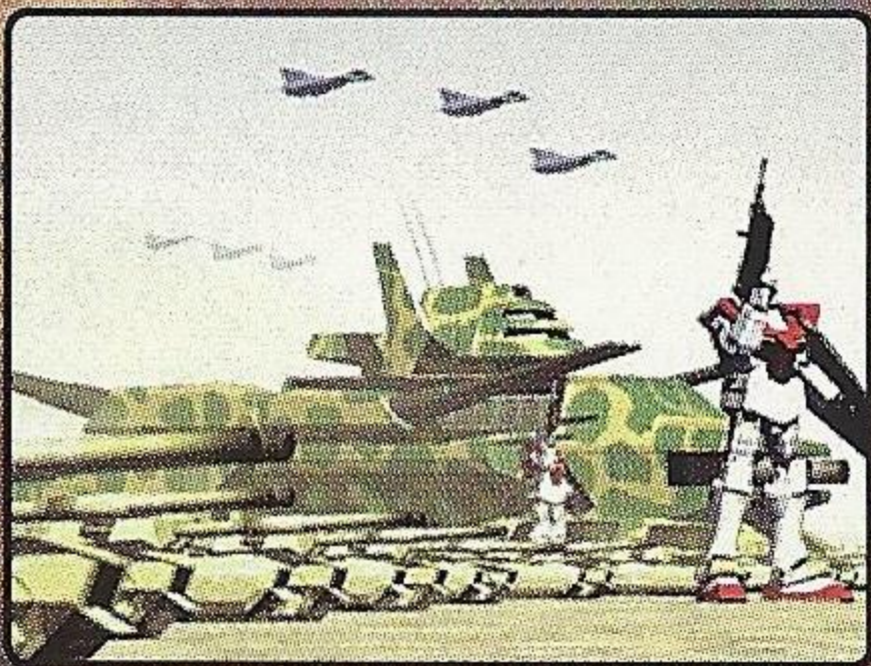
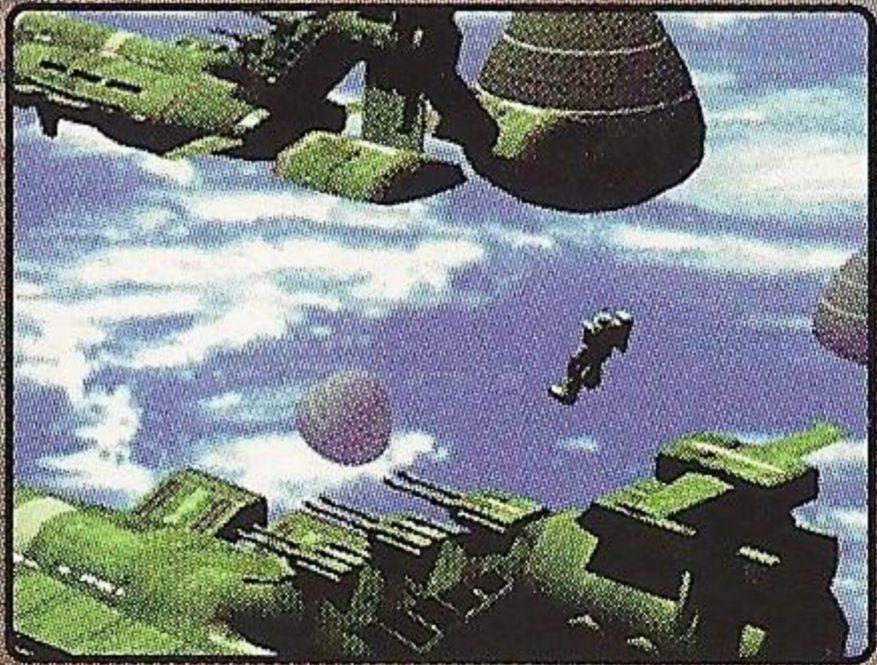
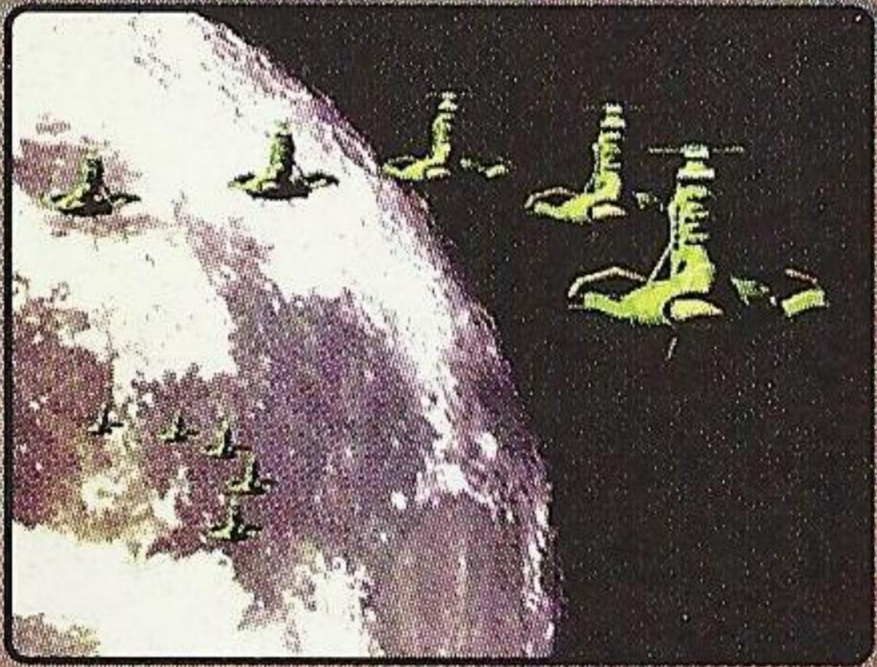

# CHARACTER



**WHITE DINGO**

11-22-UC 0079. In Australia, hard hit by the fallen colony, a Federation Army counteroffensive begins. Three main combat units simultaneously attack three key locations, in the hope of using them as springboards to seize control of the entire continent. A newly commissioned MS team known as White Dingo provides guerrilla support for these main combat units. Working under the direct command of Stanley Hawkins (Earth Federation Army Commander, Australian Front), White Dingo patrols the high-risk region between the battle lines, preparing the way to victory.

## MASTER PIERCE RAYER

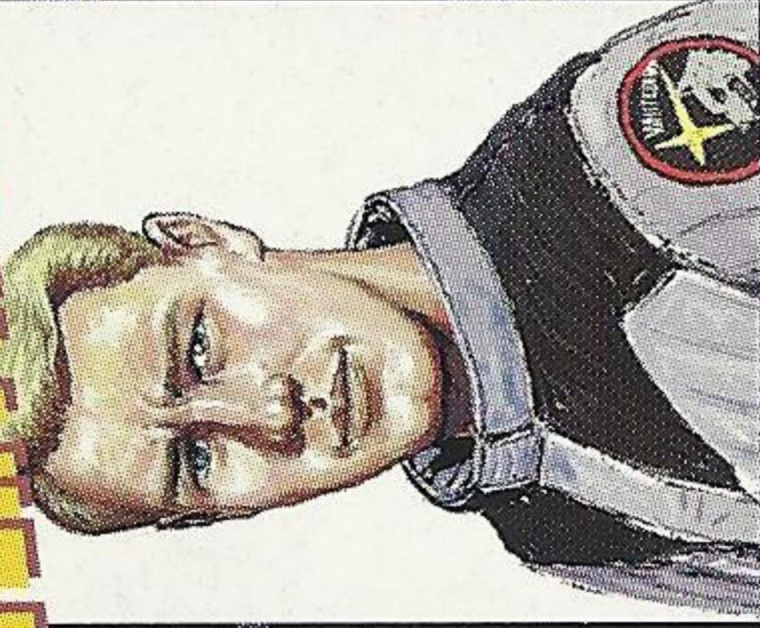

**AKA:** Rayer

**Rank:** Lieutenant Junior Grade

**Age:** late 20s

White Dingo leader and mobile suit pilot, formerly a fighter pilot. Competent and cunning, the unit's confidence in him is high. During combat, he is called FANG1.

## STANLEY HAWKINS



**Rank:** Commander

**Age:** 40s

Comes from a military family and is considered able but cautious, leading some among the Federation elite to question his mettle. However, he is friendly to his men, and their confidence in him is high.

# LEUNG LEE-TAI



**AKA:** Leung  
**Rank:** Ensign  
**Age:** Late 20s

Leung responds to every challenge with a cool head. A mobile suit pilot, he was formerly a tank driver. During combat he is called FANG2.

# MAXIMILIAN BERGER



**AKA:** Mike  
**Rank:** Ensign  
**Age:** mid-20s

Thinker, lover and connoisseur, left the military band to become a mobile suit pilot when tests showed high aptitude. In combat called FANG3.

# ANITA JULIANNE

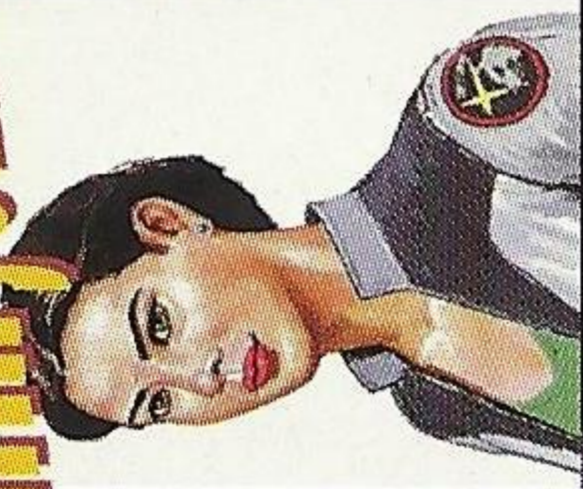

**AKA:** Anita  
**Rank:** Chief Petty Officer  
**Age:** mid-20s

A spirited and passionate woman commanding the unit's hover truck OASIS. Superb hearing equips her for combat radar reconnaissance.

# VISCH DONAHUE



**Rank:** 1st Lieutenant  
**(group leader, Zeon Forces)**  
**Age:** early 30s

Known as Wild Thunder, his specialty is the mobile attack. Said to fight twice as long and destroy three times the enemy as any team member, he is the main character's rival.



# WALTER CURTIS

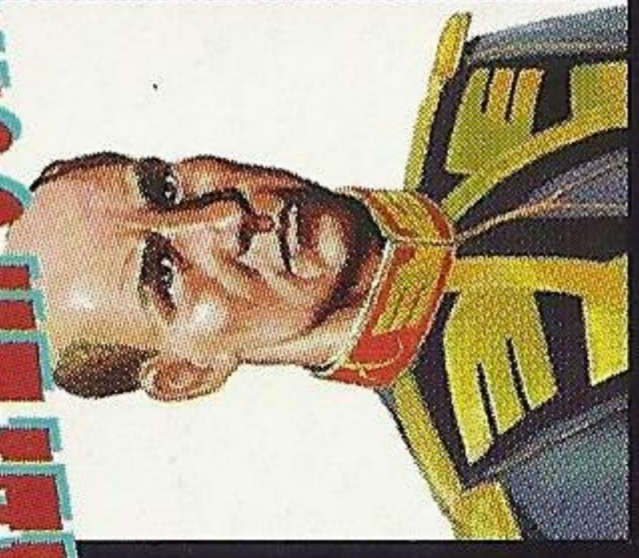

**Rank:** Lt. Colonel  
**(Commander, Zeon Forces)**  
**Age:** late 40s

A warrior with a strict code of conduct and a strong sense of justice, he believes this war is a Holy War, and vigorously opposes looting and involving civilians in combat.

# START GAME

## HOW TO BEGIN

Press the Open button on the Sega Dreamcast unit, open the disc door, properly insert the Sega Dreamcast software, "Mobile Suit Gundam Side Story 0079," and close the disc door. Press the Power button to turn on the power and the opening will begin. When the opening is over, the title screen will appear (the opening can be skipped by pressing the Start button). If you press the Start button during the title screen, you will enter the Memory Card (Visual Memory Unit – sold separately) Selection screen.

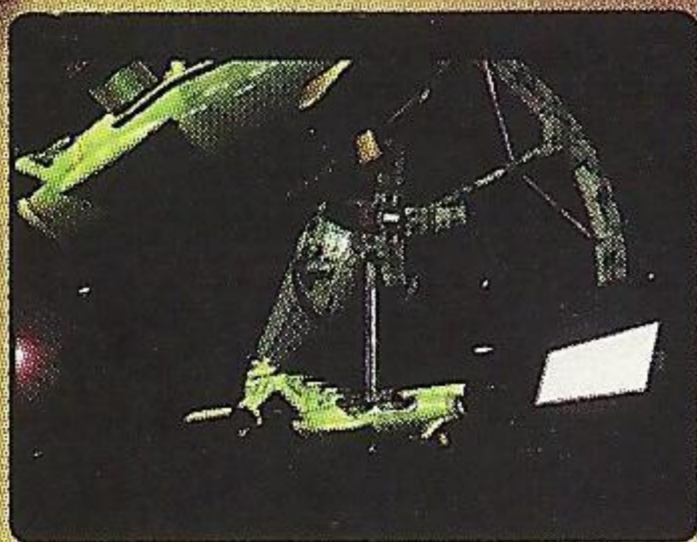

Opening

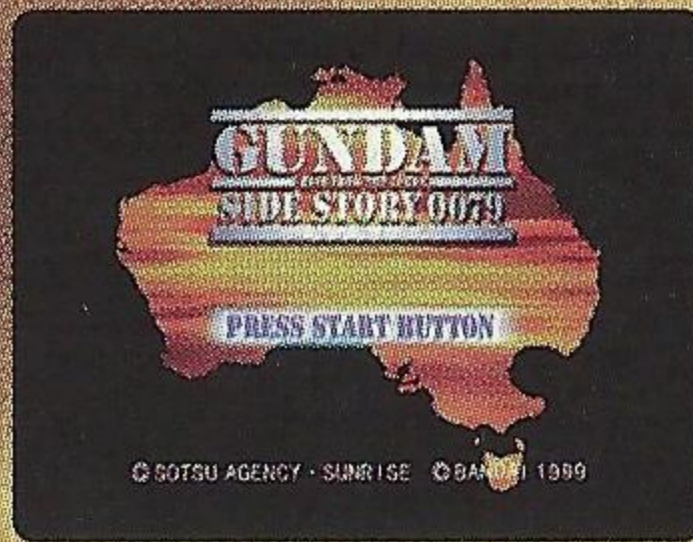

Title Screen

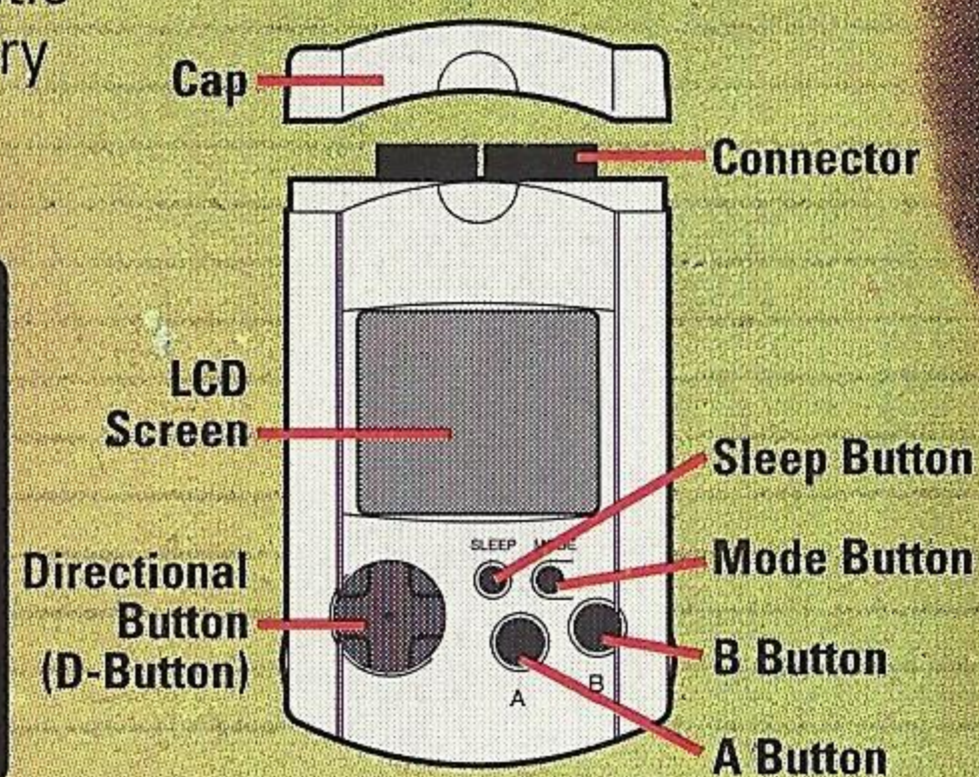

Visual Memory Unit

## MEMORY CARD SELECTION SCREEN

Use the directional button (up and down) to choose a memory card, then select it with the A button. You can save up to three games on a single memory card (the memory card needs a total of six empty blocks). While saving a game file, never turn the power Off, remove the memory card, or disconnect the controller.

- When a game has been started after a memory card has been selected, you will not go to the Memory Card Selection screen after returning to the Title screen, but to the Menu screen.
- If you want to change a memory card during a game, select **MEMORY CARD** in the Options screen and change the card (see p. 19).
- The number of memory blocks required to save game files varies according to the type of software and content of files to be saved. With this game, a total of 6 blocks are required to save game and options settings. The options settings will be automatically saved when the options menu is exited.

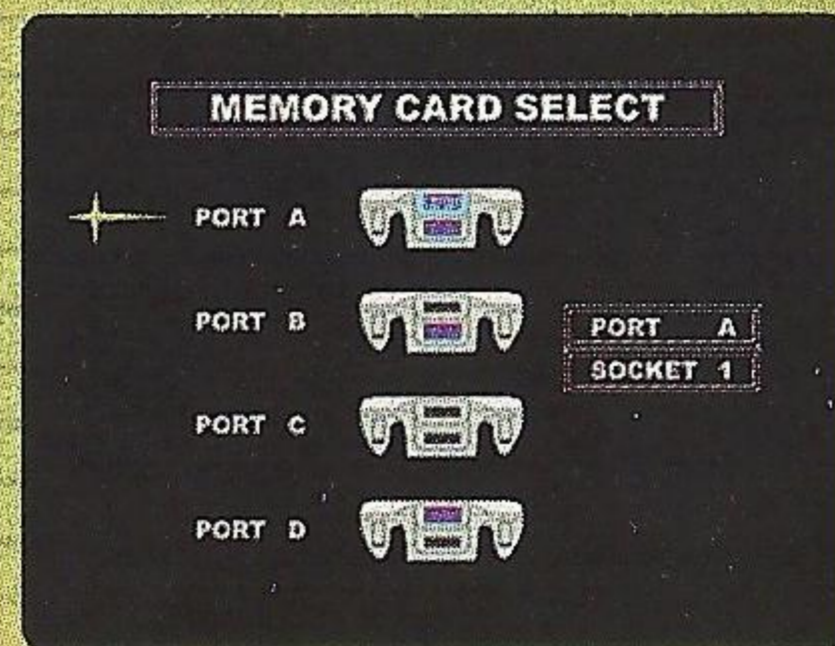



## MENU SCREEN

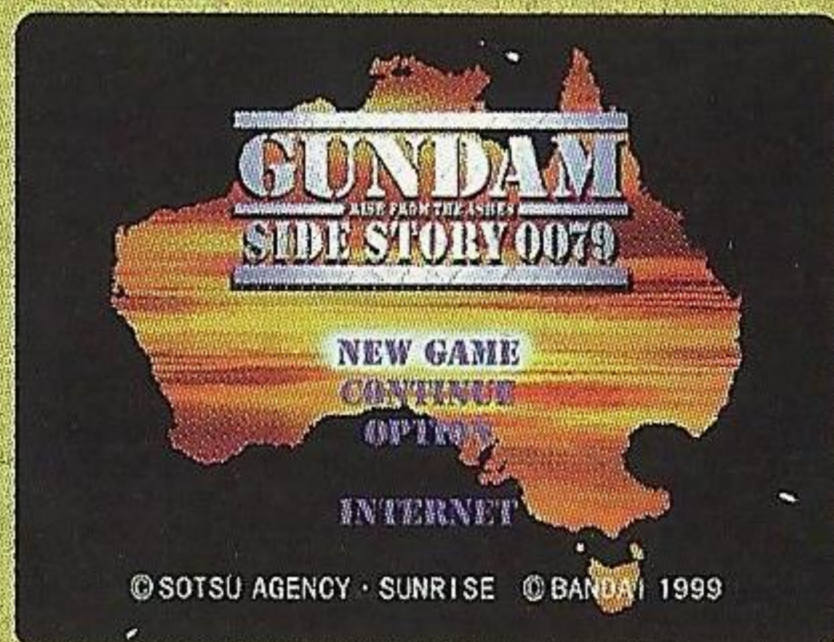

**NEW GAME:** Select to play game from the beginning.

**CONTINUE:** Select to continue playing a game.

**OPTION:** Select to set button configuration, game difficulty, etc.

## FILE SELECTION SCREEN

If you select CONTINUE in the Menu screen, you will go to the File Selection screen. Select the file for the game you want to continue from the three files on the memory card you previously selected.

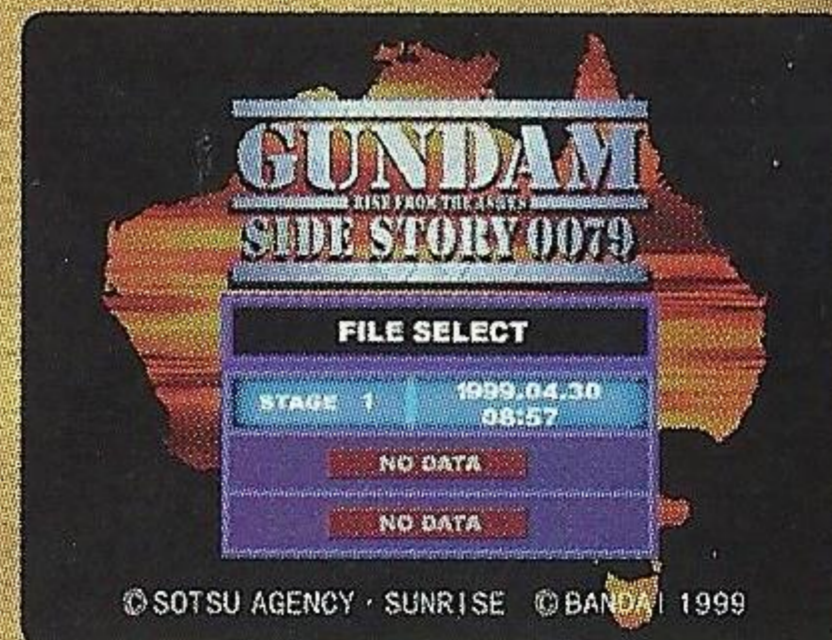

Gundam Side Story is a 1 player game. Before turning the Sega Dreamcast power on, connect the controller or other peripheral equipment to the control ports of the Sega Dreamcast. To return to the title screen at any point during game play, simultaneously press and hold the A, B, X, Y and Start buttons. This will cause the Sega Dreamcast to soft-reset the software and display the title screen.

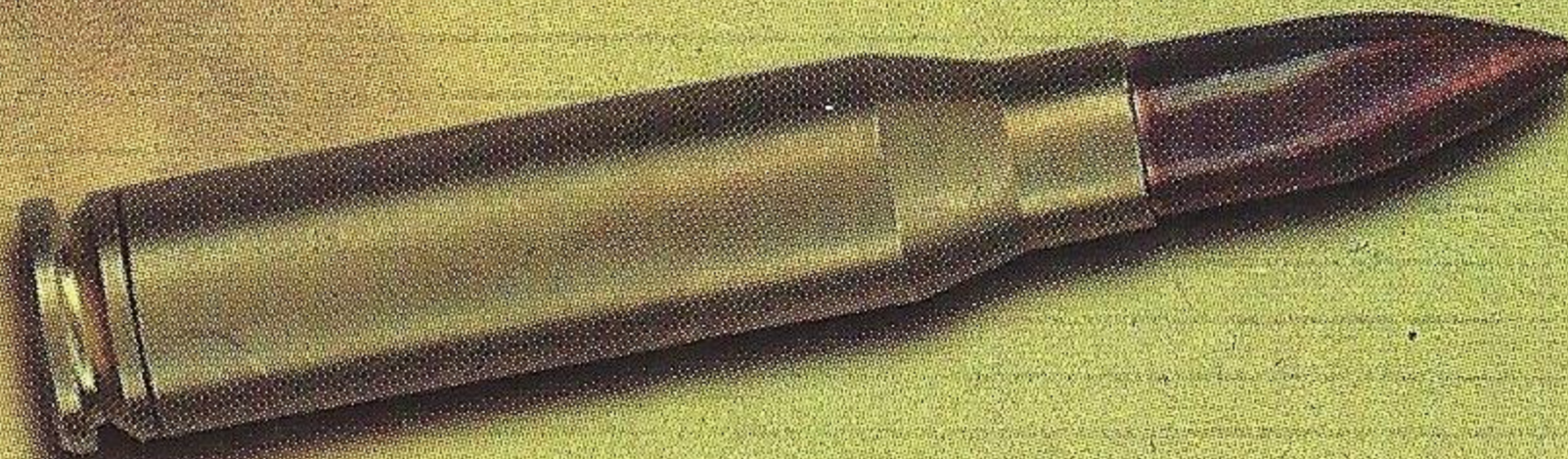

# BRIEFING

When the game is started, the B.I.C. System (see p. 15) will activate, and details of the mission will be displayed by Commander Hawkins. The Briefing screen plays an important role in making preparations before combat, such as reconfirming mission details and getting information from your teammates. Once your preparations are made, select EXIT. The mission intro will continue, and combat will begin.

## BRIEFING



Here you confirm your orders and mission details from the Commander.

## GARAGE

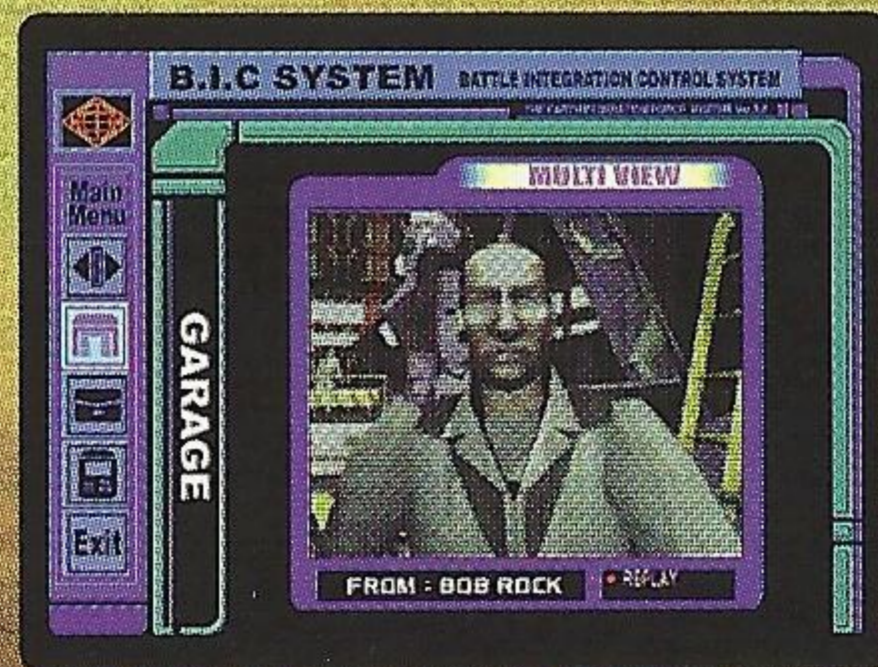

In this mode, you can change your mobile suit or weapons selections.

## MAILBOX



Here you check information e-mailed from your White Dingo teammates.

## SYSTEM

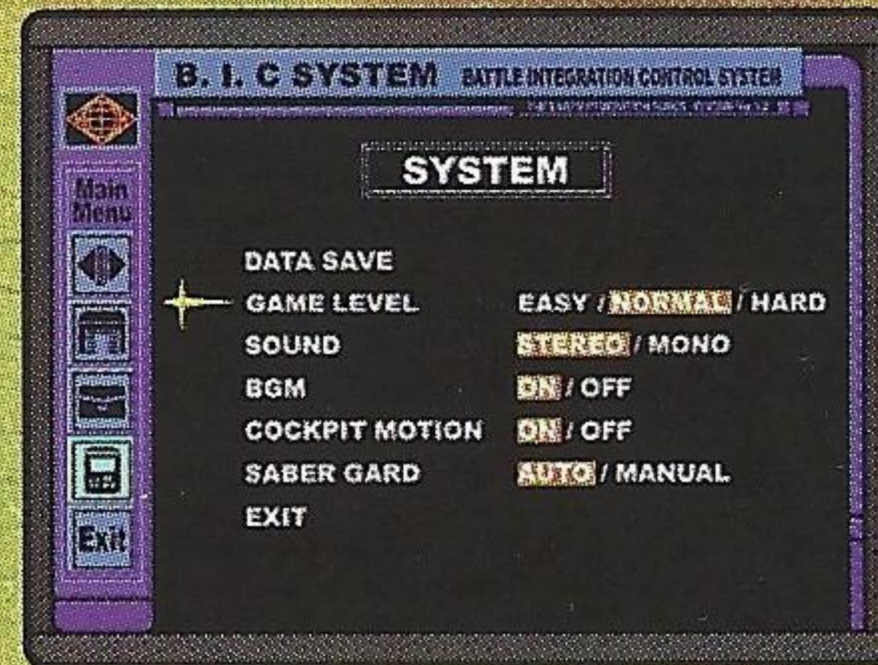

Here you can change the game's difficulty and sound, and save settings (see p. 16).

## GARAGE

When you select Garage in the Briefing screen, you enter the Unit Selection screen. Here, you confirm which mobile suits and armaments FANG 1, FANG 2 and FANG 3 will use by changing the mobile suit and weaponry selections.

### GARAGE

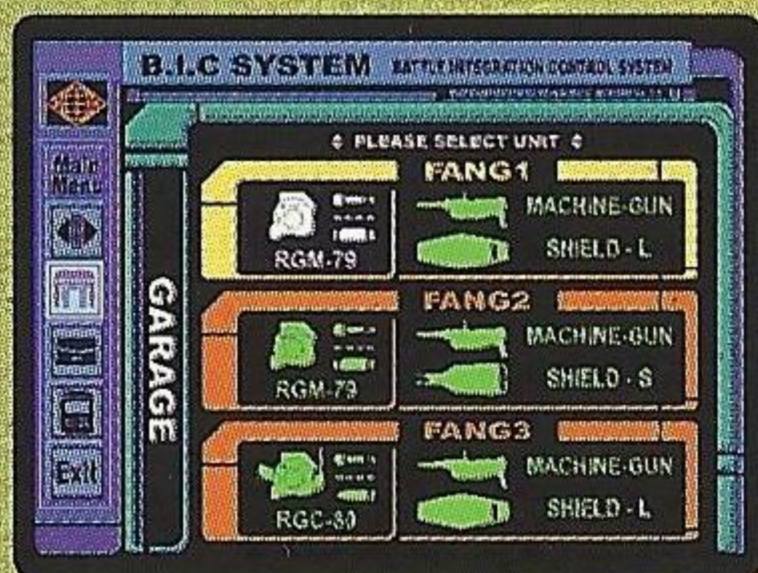

In the Unit Selection screen, select FANG 1, 2, or 3 with the up/down directional buttons and press button A to select. This will send you to the Mobile Suit Selection screen.

### MOBILE SUIT

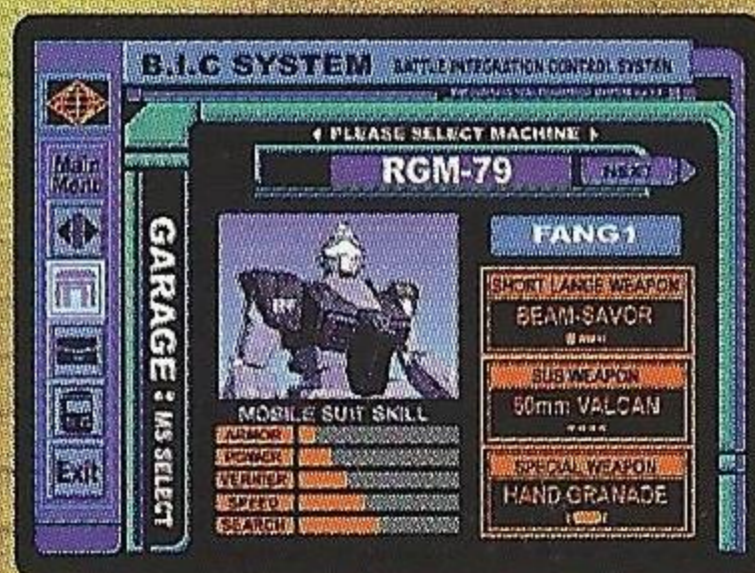

In the Mobile Suit Selection screen, select a mobile suit with the left/right directional buttons, and press button A to select. This will send you to the Weapon Selection screen.

### WEAPON

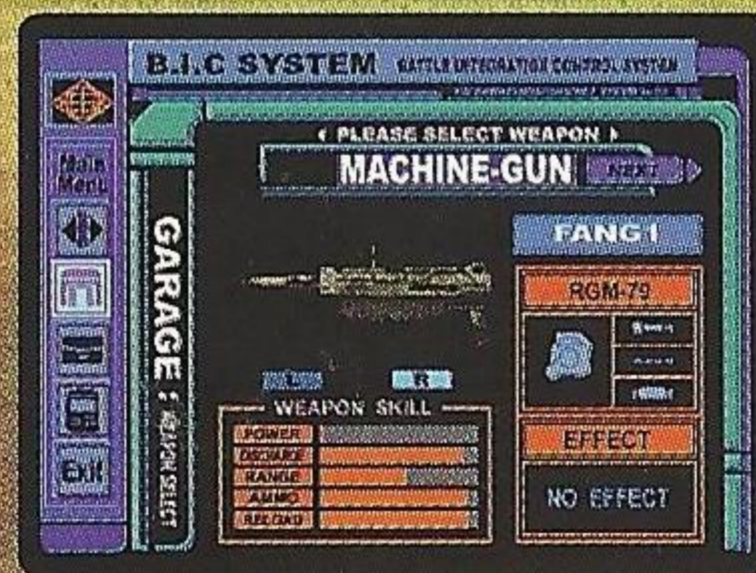

In the Weapon Selection screen, select your primary weapon with the left/right directional buttons, and press button A to select. This will send you to the Shield Selection screen.

### SHIELD

# BOB ROCK



**AKA: Bob.**  
**Rank: Chief Mechanic**  
**(Earth Federation Army)**  
**Age: Late 40s.**

A mechanic of unsurpassed skill, Bob is popular with the pilots for the wisdom of his pre-mission advice. The default mobile suit and equipment selections for FANG 1, 2, and 3 are decided by Bob.



In the Shield Selection screen, select your shield type with the left/right directional buttons, and press button A to select. This returns you to the Unit Selection screen. Repeat to select settings for the other units.

# MAINFRAME

## NORMAL MODE SCREEN GUIDE AND CONTROLS

(1) **DIRECTION INDICATOR**  
Indicates the direction your mobile suit is facing.

(2) **UNIT INFORMATION**  
Displays information on unit under Search Cursor.

(3) **SEARCH CURSOR**  
Appears if unit is caught in middle of screen. Locks on if Lock On button is pressed.

(4) **LOCK ON CURSOR**  
Shows currently locked enemy. Changes shape in response to its condition.

(5) **DISTANCE COUNTER**  
Indicates distance to currently locked enemy.

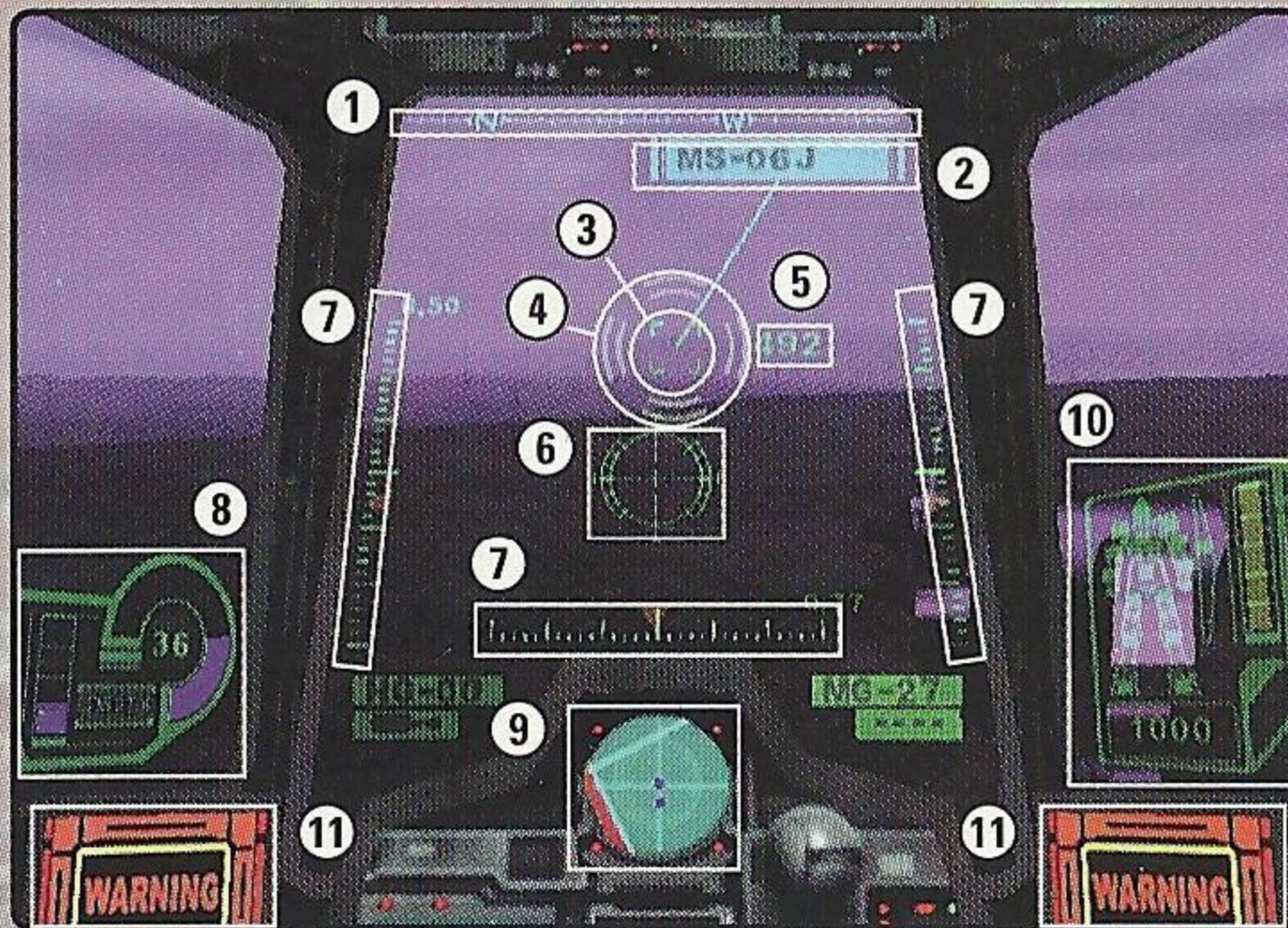

(6) **TARGETING CURSOR**  
Projectiles will fire in direction of Targeting Cursor.

(7) **VIEWING ANGLE**  
Indicates camera angle.

(8) **VERNIER GAUGE**  
Rises when moving rapidly or jumping. At MAX, will overheat and become temporarily unusable.

(9) **SHORT-RANGE RADAR**  
Blips show position of both enemies and friendlies.

(10) **DAMAGE PANEL**  
Shows mobile suit's armor values and damage condition.

(11) **WARNING PANEL**  
Lights up when attacked by enemy outside field of vision.

(12) **MESSAGE WINDOW**  
Displays various information during combat.

(13) **VULCAN GAUGE**  
Indicates barrel heat level of head-mounted Vulcan cannons. At MAX, they overheat and become temporarily unusable.



(14) **GRENADE GAUGE**  
Vertical axis shows throwing power, horizontal axis shows throwing angle, together they indicate flight distance.



(15) **SPECIAL WEAPON AMMUNITION REMAINING**  
Indicates ammunition remaining for special weaponry, such as hand grenades or cannons. When the count reaches zero, the weapon becomes unusable.

(16) **MAIN WEAPON AMMUNITION REMAINING**  
Indicates ammunition remaining for your main weapon. When it reaches zero, there will be a time lag due to magazine swapping.

## CONTROLS

### ANALOG THUMB PAD\*

Adjusts viewing angle.

### DIRECTIONAL BUTTON

UP: Move forward

DOWN: Move backward

LEFT: Turn left

RIGHT: Turn right

UP X 2: Fast advance using verniers

DOWN X 2: Crouch

LEFT X 2: Sidestep left using verniers

RIGHT X 2: Sidestep right using verniers

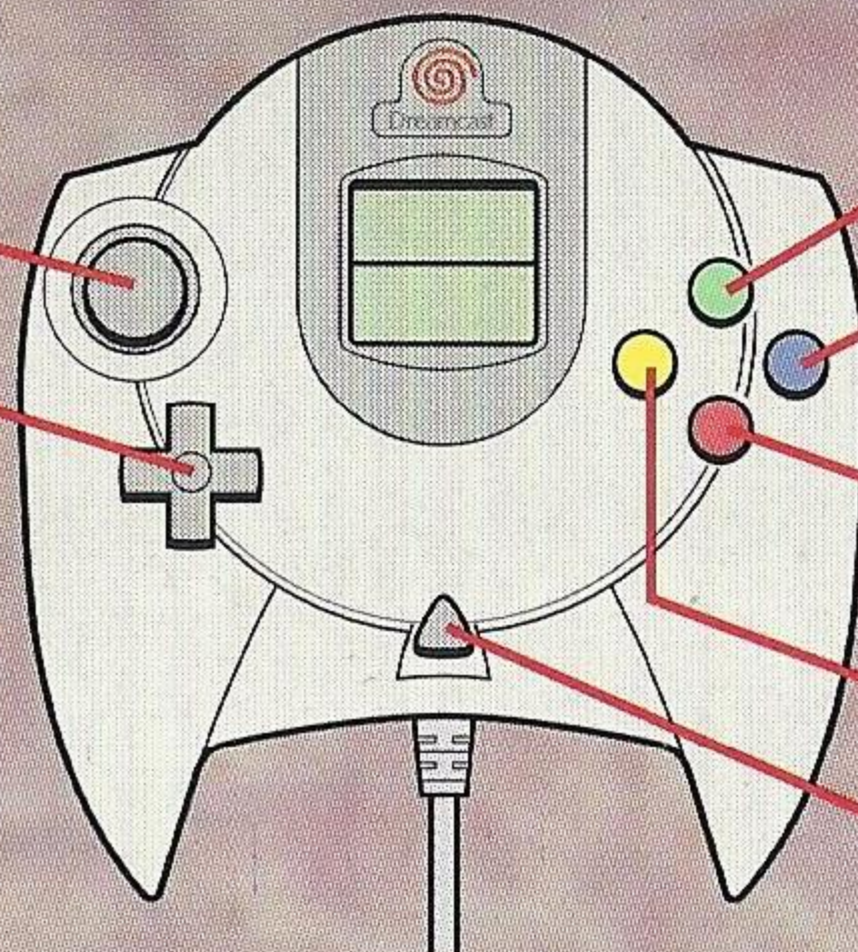

### Y BUTTON

Activate Sniper Scope.

### B BUTTON

Lock ON/OFF when Search Cursor is present.

When Search Cursor is not present, holding the button down will return view angle to default.

### A BUTTON

Attack with equipped or selected weapon.

### X BUTTON

Change weapons.

### START BUTTON

Activate B.I.C. System. (Pause.)

### R TRIGGER\*

Guard.

R Trigger + Left: Sidestep left

R Trigger + Right: Sidestep right

### EXPANSION SOCKET 1

Insert memory card.

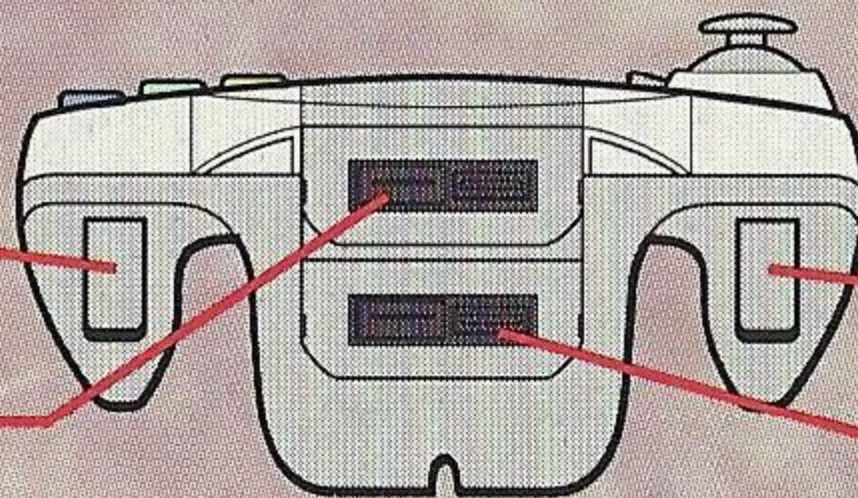

(Front View)

### L TRIGGER \*

Jump. (Will hover when held down.)

### EXPANSION SOCKET 2\*\*

Insert Jump Pack.

Gundam Side Story is a 1 player game. Before turning the Sega Dreamcast power on, connect the controller or other peripheral equipment to the control ports of the Sega Dreamcast. To return to the title screen at any point during game play, simultaneously press and hold the A, B, X, Y and Start buttons. This will cause the Sega Dreamcast to soft-reset the software and display the title screen.

\*Never touch the Analog Thumb Pad or L/R Triggers while turning the Sega Dreamcast power ON. Doing so may disrupt the controller initialization procedure and result in malfunction.

\*\* When playing game with Jump Pack attached, make sure Jump Pack is inserted into Expansion Socket 2.



### CLOSE-QUARTERS COMBAT

When within 100 meters of an enemy mobile suit that is locked on, you will enter AD (advanced) Lock-on and automatically switch to close-quarters combat.

A BUTTON: Middle Attack

UP + A BUTTON: High Attack

R TRIGGER: Saber Guard

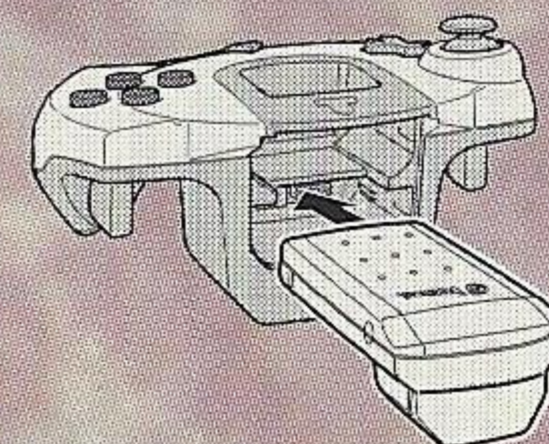

# SNIPER FRAME

## SNIPING MODE SCREEN GUIDE AND CONTROLS

(1) **DIRECTION INDICATOR**  
Indicates the direction your mobile suit is facing.

(2) **UNIT INFORMATION**  
Displays information on unit under Search Cursor.

(3) **SEARCH CURSOR**  
Appears if unit is caught in middle of screen. Locks on if Lock On button is pressed.

(4) **LOCK ON CURSOR**  
Shows currently locked enemy. Changes shape in response to its condition.

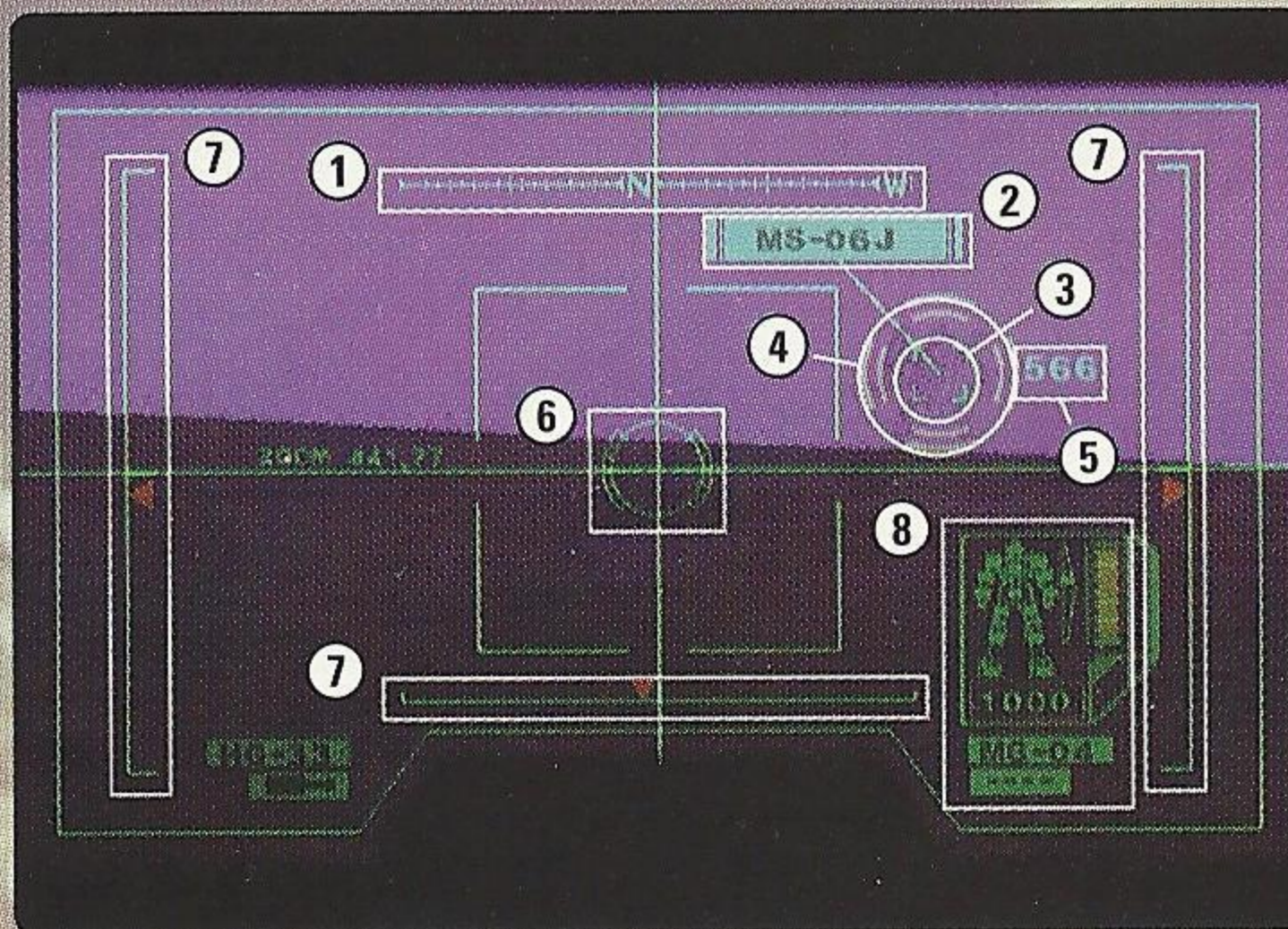

(5) **DISTANCE COUNTER**  
Indicates distance to currently locked enemy.

(6) **TARGETING CURSOR**  
Projectiles will fire in the direction of the Targeting Cursor.

(7) **VIEWING ANGLE**  
Indicates camera angle.

(8) **DAMAGE PANEL**  
Indicates your mobile suit's armor values and damage condition.

(10) **MESSAGE WINDOW**  
Displays various information during combat.

(11) **VULCAN GAUGE**  
Indicates barrel heat level of head-mounted Vulcan cannons. At MAX, they overheat and become temporarily unusable.

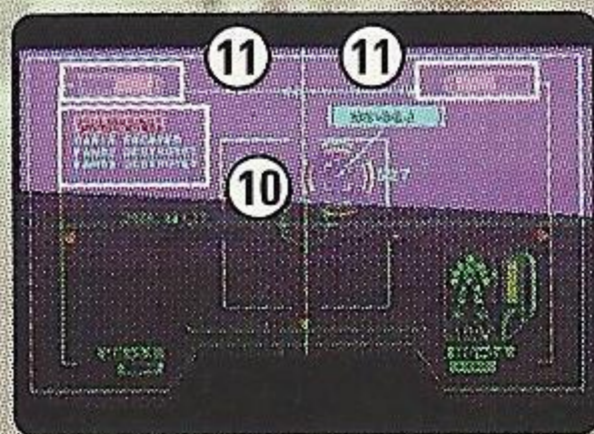

(12) **GRENADE GAUGE**  
Vertical axis shows throwing power, horizontal axis shows throwing angle, together they indicate flight distance.

(13) **SPECIAL WEAPON AMMUNITION REMAINING**  
Indicates ammunition remaining for special weaponry, such as hand grenades or cannons. When the count reaches zero, the weapon becomes unusable.

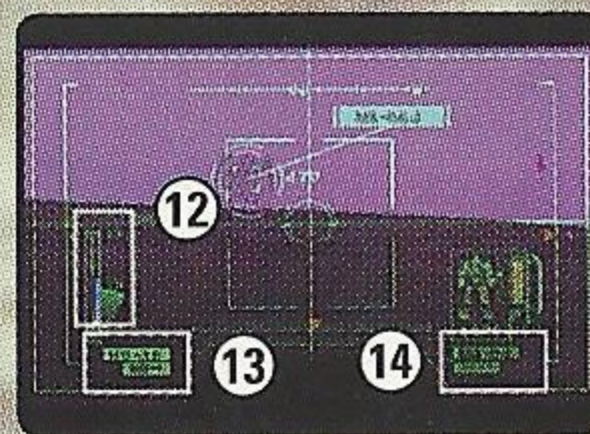

(14) **MAIN WEAPON AMMUNITION REMAINING**  
Indicates ammunition remaining for your main weapon. When it reaches zero, there will be a time lag due to magazine swapping.

## CONTROLS

**ANALOG THUMB PAD**  
Adjusts viewing angle.

**DIRECTIONAL BUTTON**  
Not used.

**START BUTTON**  
Activate B.I.C. System.  
(Pause.)

**Y BUTTON**  
Sniper Scope off.

**B BUTTON**  
Lock ON/OFF when Search  
Cursor is present.  
When Search Cursor is not  
present, holding the button  
down will return view angle  
to default.

**A BUTTON**  
Attack with equipped or  
selected weapon.

**X BUTTON**  
Change weapons.

**R TRIGGER**  
Zoom out.

**EXPANSION SOCKET 1**  
Insert memory card.

**L TRIGGER**  
Zoom in.

**EXPANSION SOCKET 2**  
Insert Jump Pack.

(Front View)

When playing game with Jump Pack attached, make sure Jump Pack is inserted into Expansion Socket 2.

# CAST

ANITA JULIANNE  
LEUNG LEE-FAI  
MAXIMILLIAN BERGER  
STANLEY HAWKINS  
WALTER CURTIS  
BOB ROCK  
VISCH DONAHUE  
JACQUELINE

## ADDITIONAL VOICES

Wendee Lee  
Sparky Thorton  
David Lucas  
Ray Michaels  
James Lyon  
Richard Barnes  
Steve Kramer  
Lia Sargent

Lex Lang  
Steve Kramer  
Dylan Tully  
Alfred Thor  
Michael Charles  
James Lyon  
Gary Michaels  
Frank Buck  
Richard Plantagenet  
Jackson Daniels  
Waylon Akers  
Billy Regan  
Joe Romersa  
Henry Douglas Grey  
John Smallberries  
Bob Marty

## NARRATOR

Jeff Sherwood

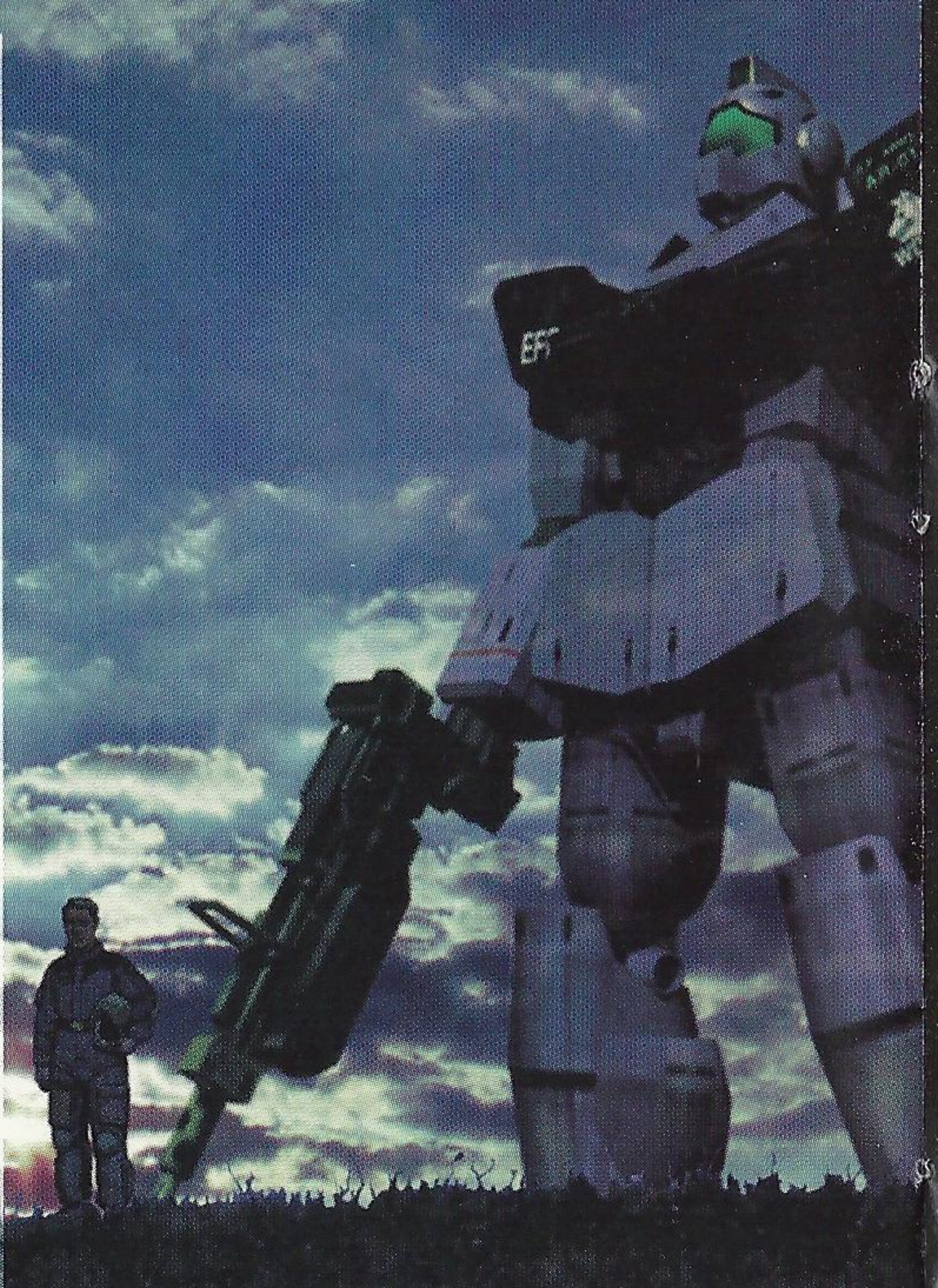



# TACTICS



## TACTICS SCREEN

When the Start button is pressed during a game, the B.I.C. System is activated and you enter the Tactics Screen, where you can check your current position, issue orders to friendly units, and verify various information (the game is paused at this point).

### MAP

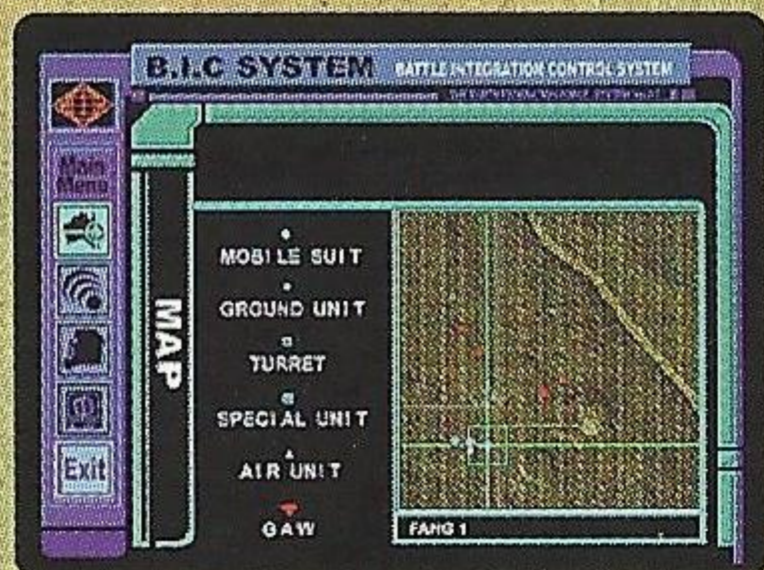

Blips indicate the field map and the positions of all units.

### COMMAND

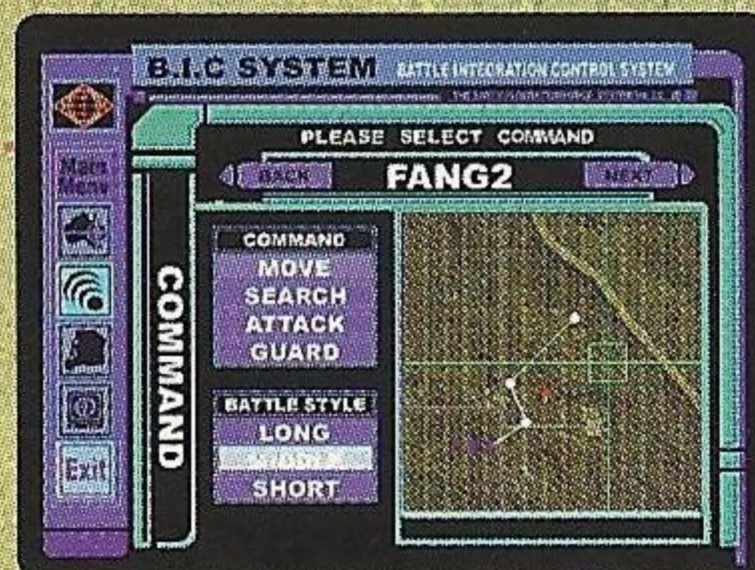

Issue various orders to friendly units.

### CONDITION



Displays condition of your unit, as well as that of friendly units.

### MISSION



Displays conditions for clearing level.

The B.I.C. System (Battle Integration Control System) is a Federation Army operation system which allows you to verify various data and issue orders to friendly units.

# COMMAND

## COMMAND SCREEN

If you select COMMAND in the Tactics Screen, you enter the Command Screen, and you can issue various orders to FANG 2, FANG 3, and OASIS.\* The commands you can issue fall under COMMAND and BATTLE STYLE.

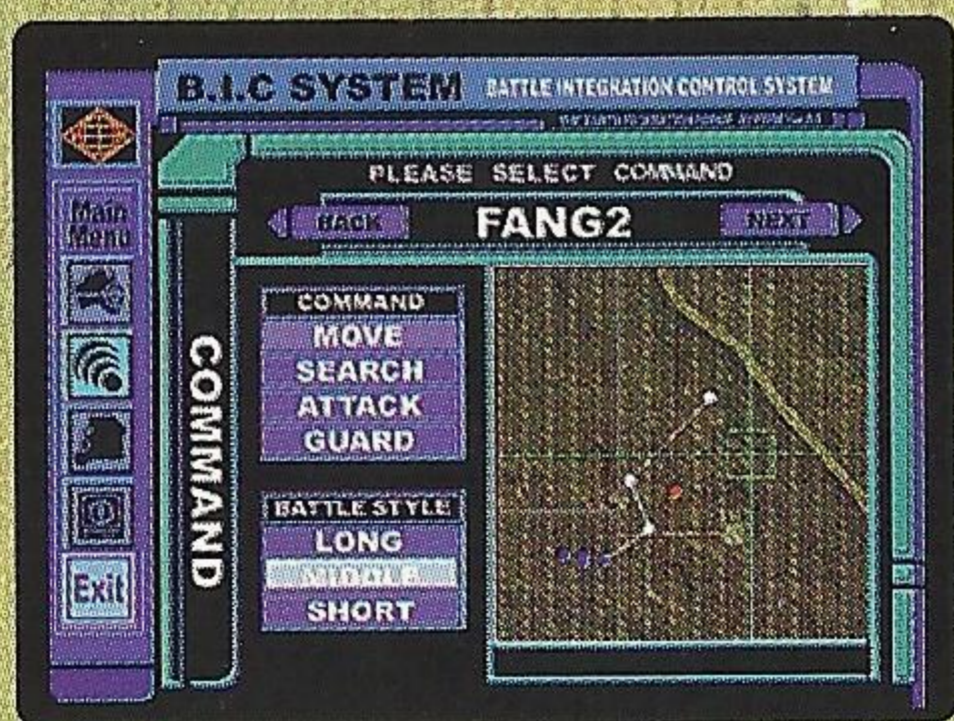

## COMMAND (Main Command)

**MOVE:** You can designate up to three waypoints within the field map to direct movement. Since priority is given to reaching the indicated waypoint, this is useful for forcing through enemy lines and retreating.

**SEARCH:** You can designate up to three waypoints within the field map for your units to reconnoiter while patrolling. After an enemy is spotted, your units will automatically shift to combat mode in accordance with the Battle Style that has been set.

**ATTACK:** Designate an enemy displayed on the map as a blip, and units will attack in accordance with the Battle Style that has been set.

**GUARD:** Units will act to defend friendly units indicated on the map as a blip.

## BATTLE STYLE

**LONG:** Combat movement for supporting long-range sniping attacks.

**MIDDLE:** Balanced combat movement with emphasis on mid-range attacks.

**SHORT:** For fighting in close quarters, where one hit can be fatal.

\*OASIS, a hover truck used exclusively for recon, does not engage in combat. Therefore, instead of ATTACK or GUARD, a command called SP. SEARCH is displayed, which uses underground radar pulses to detect moving bodies within the map.

## USING THE COMMAND SCREEN

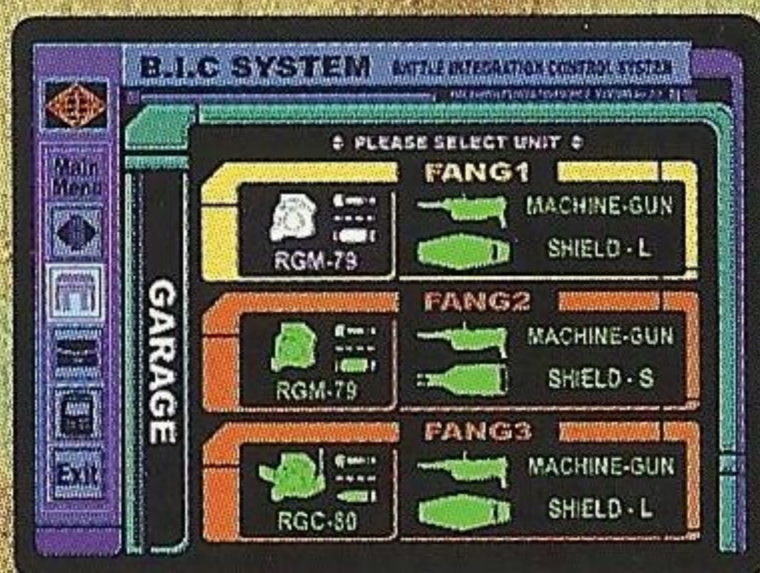

In the Command Screen, you can use the left/right directional buttons to select friendly units FANG 2, FANG 3, and OASIS. Select the unit you want to issue orders to, and press the A button (FANG 2 is selected here).

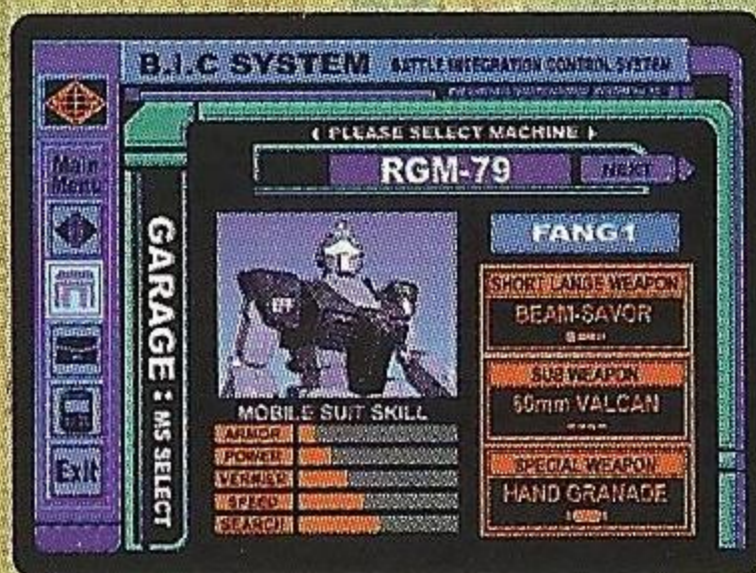

When you select a unit, you can then select your Main Command and Battle Style. Use the up/down directional buttons to choose, and then press the A button to set (MOVE and MIDDLE are selected here).

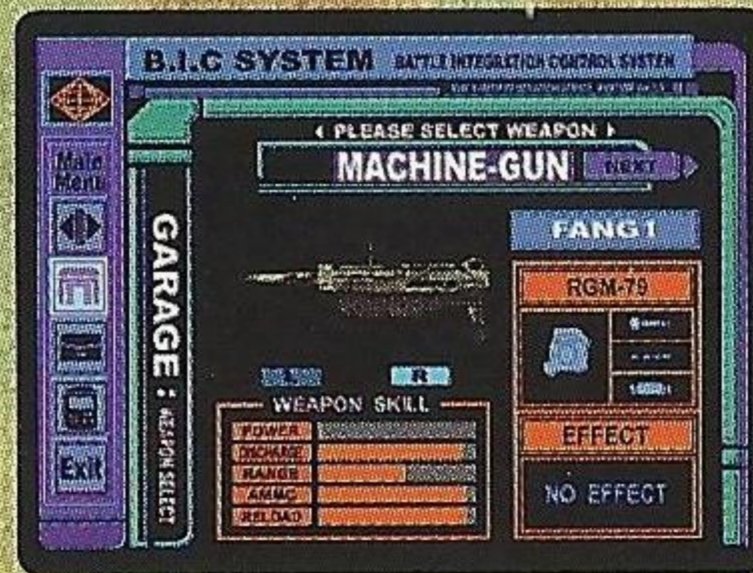

When you select your Main Command, operations transfer to the Field Map. Move the cursor with either the directional buttons or the analog stick to the location where you want the unit to move, and press the A button to set (if you make a mistake, press the X button to clear). You can indicate up to three waypoints.

When you are done, press the Start button and you will return to the main game. The units to which you've issued orders will begin to move. If you wish to issue orders to a different friendly unit, press the B button and go back through the screens, select another unit, and repeat these steps.

E.F. ARMY AUSTRALIA WHITE DINGO

# GAME OVER / SYSTEM

## GAME OVER

If your unit's armor count reaches 0, or if you ignore the warnings and leave the combat area, you will see the Continue Screen. If you press the Start button within the time limit, you can start the game from that same level, but if you do not continue, the game ends.

CONTINUE?

8

## SYSTEM

If you select SYSTEM in the Briefing Screen, you enter the System Screen and can change the game's difficulty and sound settings, as well as save a game.

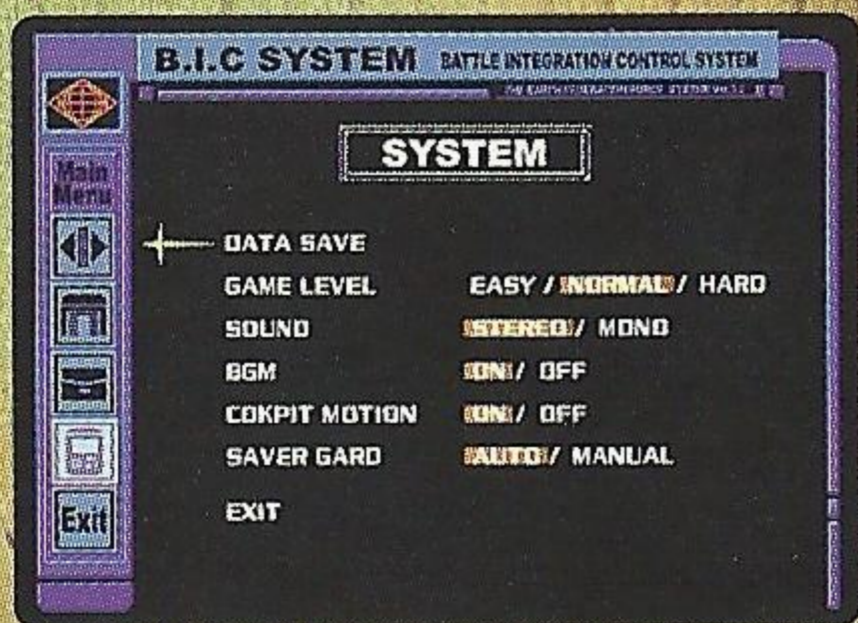

**DATA SAVE:** Lets you save your game. You can save up to three games on a single memory card.

**GAME LEVEL:** Lets you select between three difficulty settings (EASY/NORMAL/HARD).

**SOUND:** Lets you select between stereo and mono.

**BGM:** Switches background music ON/OFF.

**COCKPIT MOTION:** Switches motion of cockpit frame ON/OFF.

**SABER GUARD:** Switches between AUTO/MANUAL saber guard for combat in close quarters.

- To save a game, a memory card (Visual Memory Unit) is necessary. (Visual Memory Unit sold separately.)
- When saving, do not turn power off, or remove memory card, expansion unit, or controller.

# OPTION

If you select OPTION from the Menu Screen, you enter the Options Screen and can change the game's settings.

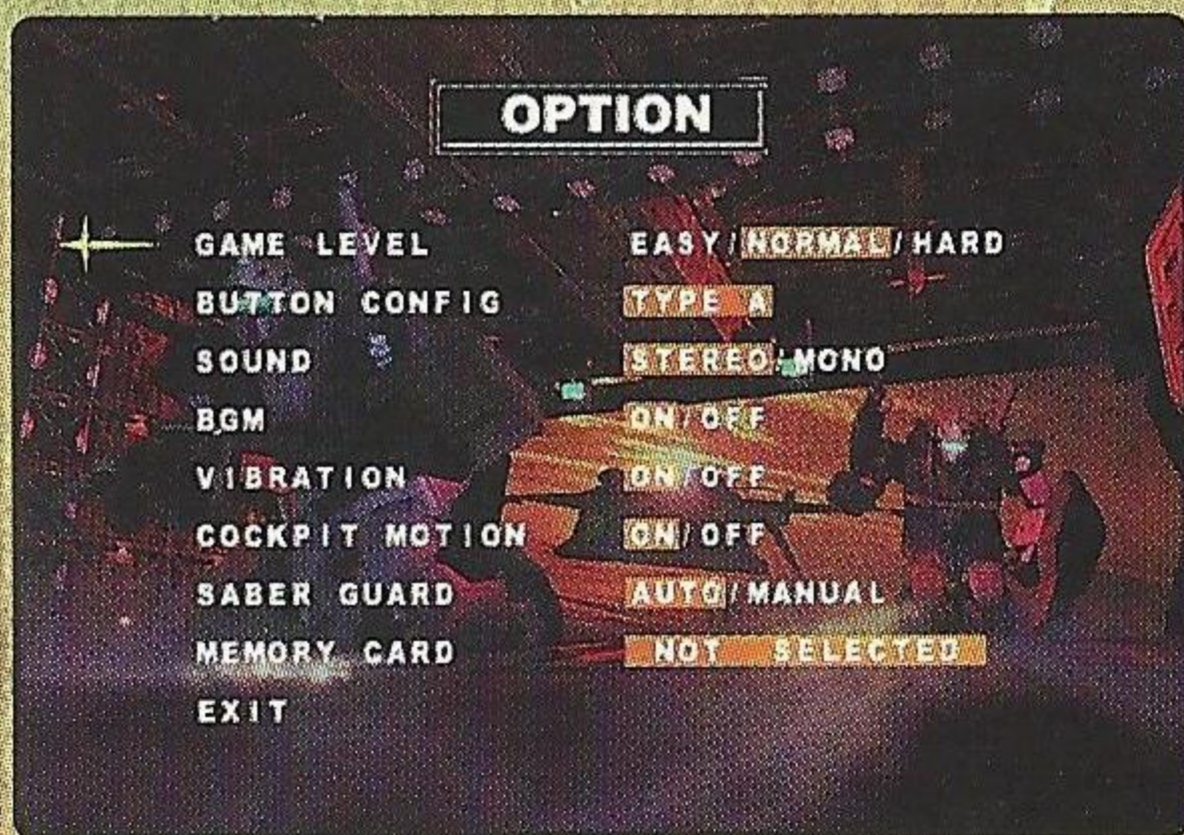

**GAME LEVEL:** Lets you select between three difficulty settings (EASY / NORMAL / HARD).

**BUTTON CONFIG:** Lets you select from several types of button layout.

**SOUND:** Lets you select between stereo and mono.

**BGM:** Switches background music ON/OFF.

**VIBRATION:** Lets you switch vibration ON/OFF.

**COCKPIT MOTION:** Switches motion of cockpit frame ON/OFF.

**SABER GUARD:** Switches between AUTO/MANUAL saber guard for combat in close quarters.

**MEMORY CARD:** Sends you to the Memory Card Screen where you can switch from the memory card the system is using to any other connected card.



# MOBILE SUIT

Mobile suits, the backbone of the Federation Army, are piloted by the members of White Dingo. The GM and GM Cannon are mass-production models, but they compare favorably to Zeon mobile suits. If you successfully complete your missions, more powerful mobile suits may be issued to you.

**MODEL NAME:** GM

**MODEL NUMBER:** RGM-79

**SPECS:** total height – 18.0 m  
dry weight – 41.2 t

## WEAPONS

**FIXED:** 60 mm head-mounted Vulcan x 2  
beam saber

**HAND-HELD:** 100 mm machine gun  
shield  
rocket launcher, etc.

**COMMENTS:** A simplified, mass production version of the Gundam developed for hand-to-hand combat. Rolled out immediately before the battle of Jabrow, and large numbers were sent into subsequent battles. The internal construction of the suits piloted by the main characters, the White Dingo, has been customized for ground combat.



**MODEL NAME:** GM Cannon

**MODEL NUMBER:** GRC-80

**SPECS:** total height – 17.8 m  
dry weight – 49.9 t

## WEAPONS

**FIXED:** 60 mm head-mounted Vulcan x 2  
beam saber  
240 mm cannon





**HAND-HELD:** 100 mm machine gun  
shield, etc.

**COMMENTS:** Redesign of the RGM-79 for bombardment use. Equipped with a 240 mm cannon on its right shoulder, and has reinforced armor. Because its primary duty is mid-range support attacks, it is not suited for hand-to-hand combat.



## WEAPON

You must understand the characteristics of the weapons and shields of the GM and GM Cannon in order to choose what is appropriate for the mission. Depending on the mission, you may be issued more powerful weapons.

WEAPON NAME		COMMENTS	LIMITATIONS
<b>60 mm head-mounted Vulcan Fixed weapon</b>		Due to low accuracy and scattered fire pattern, most effective at strafing ground targets. Single shots do light damage, but can be fired continuously	May become temporarily unusable due to barrel heat, but shells are unlimited.
<b>100 mm machine gun Primary weapon</b>		Multi-purpose weapon, easy to use, effective in any mission. One shell doesn't cause much damage, but it can be fired continuously.	After set number of shots, magazine must be changed.
<b>Rocket launcher Primary weapon</b>		Detonated by proximity fuse, inflicts damage over given area. One shot causes a great deal of damage, but it can't be fired continuously.	After set number of shots, magazine must be changed.
<b>Hand grenade Special weapon</b>		Flight distance can be adjusted as needed, but they are hard to use. One grenade does extensive damage, but they can't be used continuously.	Ammunition is limited.
<b>240 mm cannon Fixed weapon</b>		Long range, fast firing makes this weapon ideal for sniping. One shot doesn't cause much damage, but it can be fired continuously.	Ammunition is limited.
<b>Beam saber Fixed weapon</b>		Powerful weapon, especially effective in close quarters combat. Automatically arms itself during AD lock on.	None
<b>Large shield</b>		Typical shield, coverage and endurance both high.	None
<b>Small shield</b>		Coverage and endurance inferior to standard shield, but has offensive capabilities when ramming.	None

# TECHNIQUE

## COMBAT FUNDAMENTALS: LOCATE THE ENEMY!

When combat begins, the first thing you must do is find the enemy. Radar is unusable under scattered Minovsky particles, so combat will be restricted to line-of-sight. In other words, the first rule of scouting out the enemy is "Observation." Keep on your toes, watch your monitor from corner to corner, and spot the enemy with your own eyes! You can also have friendly units reconnoiter for you. By issuing MOVE and SEARCH orders to FANG 2 and FANG 3 in the Tactics Screen and having them move around, you can have enemy units that show up on their monitors appear on your map. You can also issue the SP. SEARCH order to OASIS. It will take time, but its underground radar will locate all units in the field.



Observation is everything. Find the enemy before he finds you.

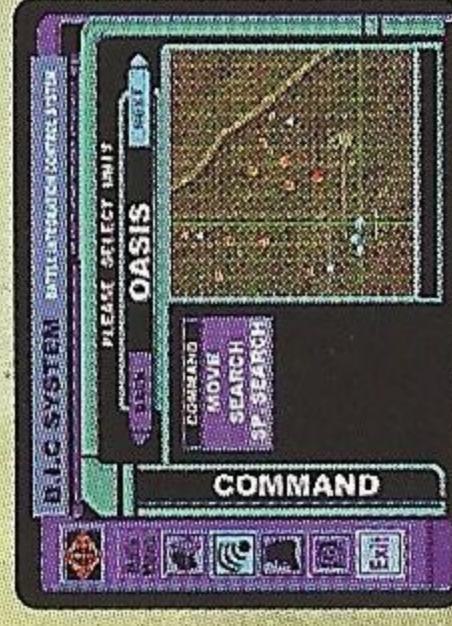

Units are displayed on the map using underground radar.

## GET A LOCK ON ENEMIES YOU'VE SPOTTED!

Once you've successfully located the enemy and have had the Search Cursor display the unit's data, get a lock on. By locking on, that enemy will automatically be kept in front of you and will be easier to fight. If the target moves behind something or leaves your field of vision momentarily, you will lose your lock. When fighting, always keep the enemy in your sights.



Keep the target locked until it's destroyed!



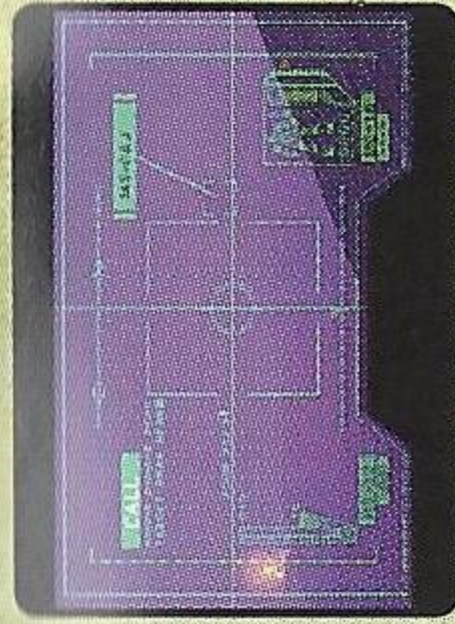

Get the hang of using the free-zooming sniper scope!

## USE THE SNIPER SCOPE!

When you've managed to get the drop on an enemy, a long-range sniping attack is effective. Use the sniper scope and take him down!

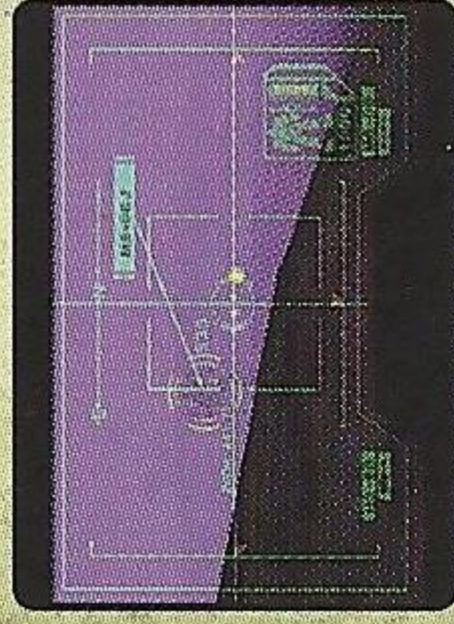

From a distance, the machine gun isn't effective.

## LEARN THE CHARACTERISTICS OF YOUR WEAPONS!

This is a ground battle, so most of your weapons use projectiles. In other words, the farther away you are, the less damage they will do. Take care when deploying your weapons, because you will have to close in on the enemy while determining your effective firing range!

## COMMAND YOUR TEAM AND CARRY OUT YOUR MISSION!

Your men, Leung and Mike, are both superb mobile suit pilots. Once you get to know the characteristics of the mobile suits they're piloting, and issue precise orders, completing your missions will become easier. Combine your Main Commands and Battle Styles effectively, and find out how to make your squad work for you!



Issue precise orders as the squad leader!

## CONTROL YOUR RANGE WITH RAPID MOVEMENT!

When the enemy leaves himself open for a split second, take advantage and rush in for combat in close quarters. Step rapidly left and right to evade enemy fire. Ram the enemy and retreat rapidly to gain some distance. Rapid movement, made possible by tapping a directional button twice, is an extremely effective tactic. Use it, but watch out for vernier overheating!



If you lose your lock when you're in close, evade!

# COLLECT ALL THESE GUNDAM PRODUCTS!

## VIDEOS!

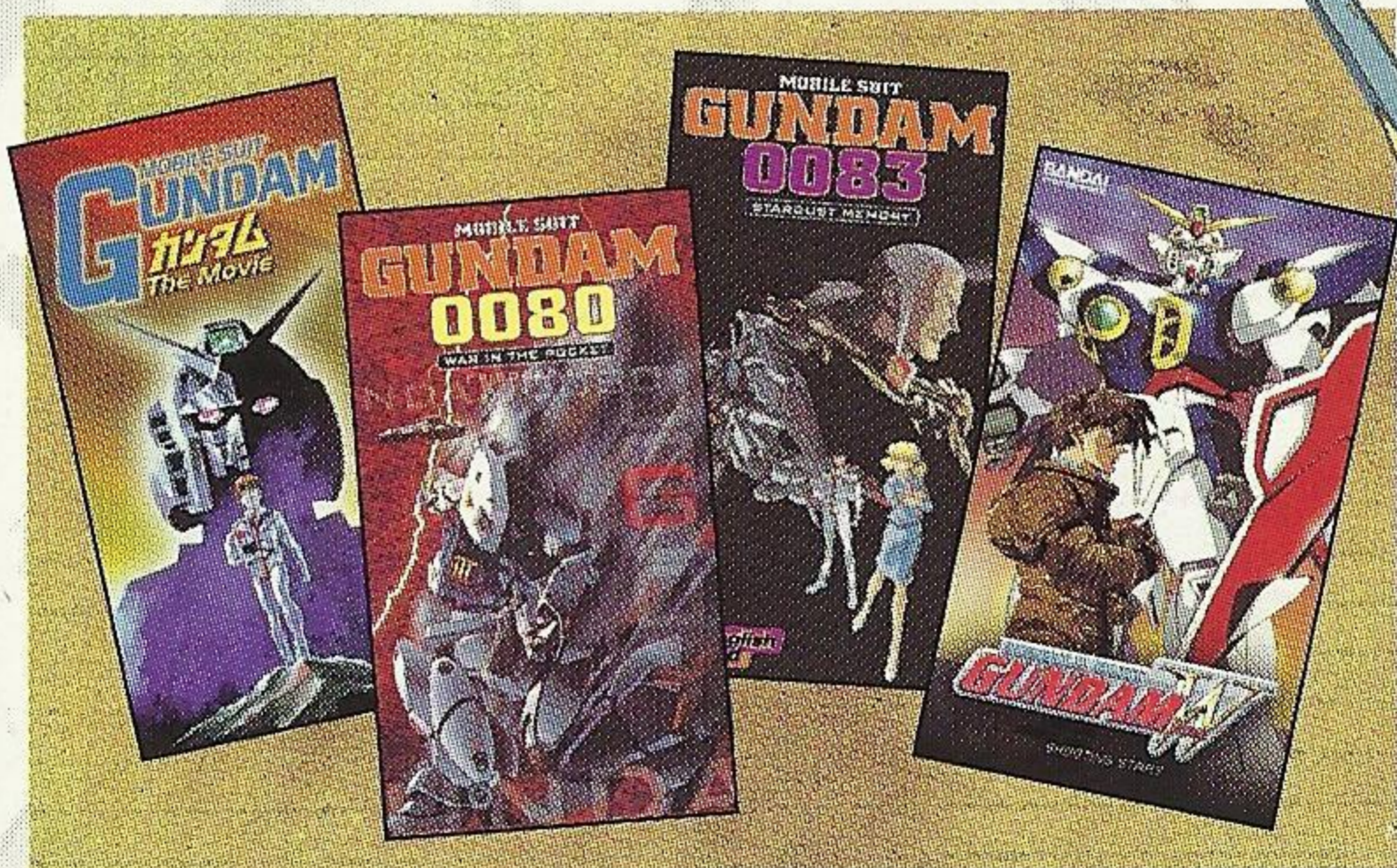

**BUILD YOUR OWN  
MOBILE SUIT!**

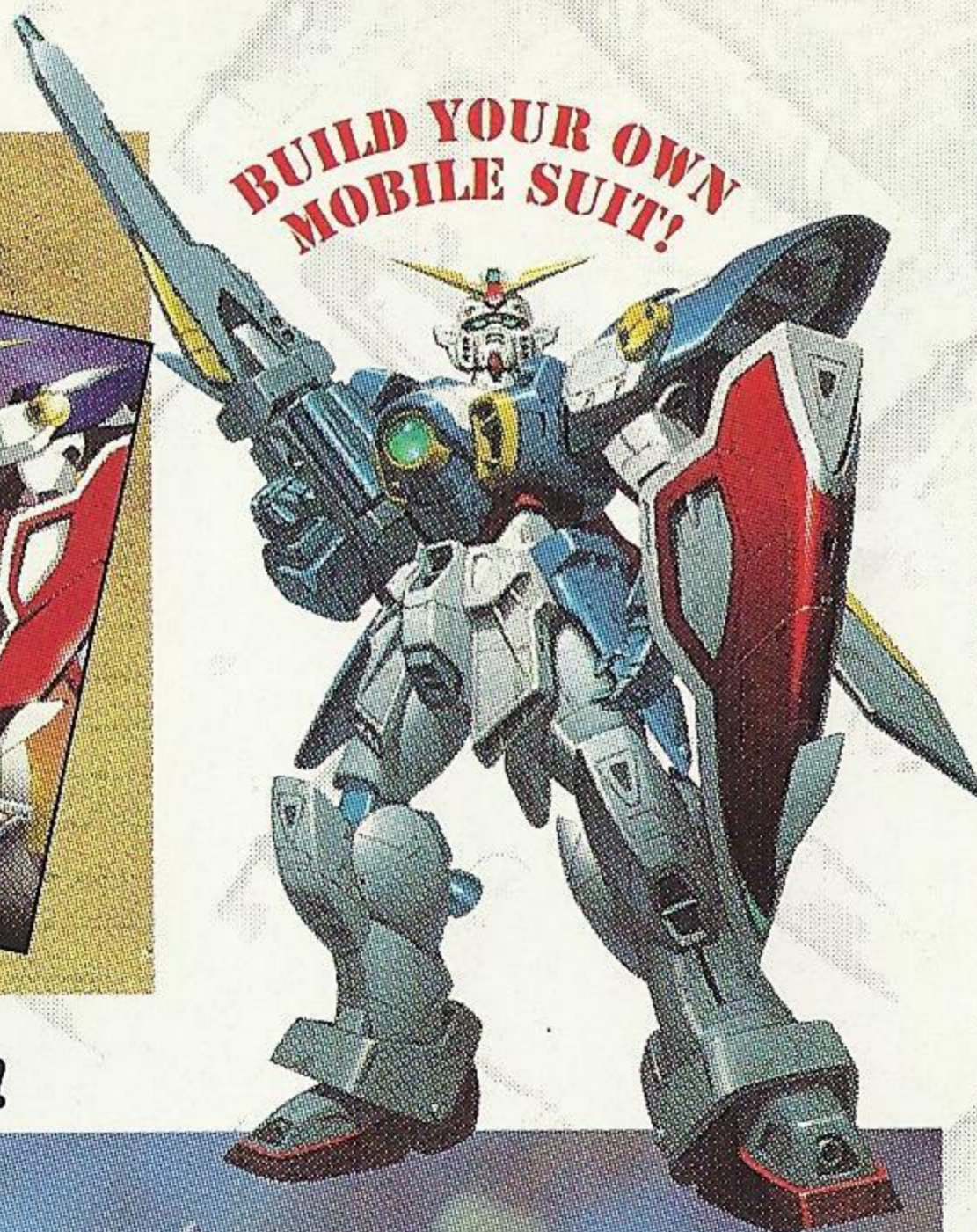

## ACTION FIGURES & MODEL KITS!



Find out more at [www.gundamofficial.com](http://www.gundamofficial.com)

## 90-DAY LIMITED WARRANTY

Bandai America Incorporated (Bandai) warrants to the original consumer purchaser that this Game Pak ("PAK") not including Game Pak Accessories shall be free from defects in material and workmanship for a period of 90 days from the date of purchase. If a defect covered by this warranty occurs during this 90-day warranty period, Bandai will repair or replace the PAK, at its option, free of charge.

### To receive this warranty service:

1. DO NOT return your defective Game Pak to the retailer.
2. Notify the Bandai Consumer Service Department of the problem requiring warranty service by calling: 1-714-816-9500. Our Customer Service Department is in operation from 9:00 A.M. to 5:00 P.M. Pacific Standard Time, Monday through Friday.
3. If the Bandai Service technician is unable to solve the problem by phone, he will provide you with a Return Authorization number. Simply record this number on the outside packaging of your defective PAK, and return your PAK freight prepaid, at your risk of damage, together with your sales slip or similar proof-of-purchase within the 90-day warranty period to:

Bandai America Incorporated.  
Consumer Service Department  
5551 Katella Avenue  
Cypress, CA. 90630

This warranty shall not apply if the PAK has been damaged by negligence, accident, unreasonable use, modification, tampering, or by other causes unrelated to defective materials or workmanship.

### REPAIRS AFTER EXPIRATION OF WARRANTY

If the PAK develops a problem after the 90-day warranty period, you may contact the Bandai Consumer Service Department at the phone number noted. If the Bandai Service technician is unable to solve the problem by phone, he may provide you with a Return Authorization number. You may then record this number on the outside packaging of the defective PAK and return the defective PAK freight prepaid to Bandai, enclosing a check or money order for \$10.00 payable to Bandai America Incorporated. Bandai will, at its option, subject to the conditions above, repair the PAK or replace it with a new or repaired PAK. If replacement PAKS are not available, the defective PAK will be returned and the \$10.00 payment refunded.

### WARRANTY LIMITATIONS:

ANY APPLICABLE IMPLIED WARRANTIES, INCLUDING WARRANTIES OF MERCHANTABILITY AND FITNESS FOR A PARTICULAR PURPOSE, ARE HEREBY LIMITED TO NINETY DAYS FROM THE DATE OF PURCHASE AND ARE SUBJECT TO THE CONDITIONS SET FORTH HEREIN. IN NO EVENT SHALL BANDAI BE LIABLE FOR CONSEQUENTIAL OR INCIDENTAL DAMAGES RESULTING FROM THE BREACH OF ANY EXPRESS OR IMPLIED WARRANTIES.

The provisions of this warranty are valid in the United States only. Some states do not allow limitations on how long an implied warranty lasts or exclusion of consequential or incidental damages, so the above limitations and exclusions may not apply to you. This warranty gives you specific legal rights and you may have other rights

### ESRB RATING

This product has been rated by the Entertainment Software Rating Board. For information about the ESRB rating, or to comment about the appropriateness of the rating, please contact the ESRB at 1-800-771-3772.

Sega is registered in the US Patent and Trademark Office. Sega Dreamcast, the Dreamcast Swirl, are trademarks of SEGA. Sega of America, P.O. Box 7639, San Francisco, CA 94120. All Rights Reserved. Programmed in Japan. Made and printed in the USA. WARNING: Operates only with NTSC televisions and Sega Dreamcast systems purchased in North and South America (except Argentina, Paraguay and Uruguay). Will not operate with any other televisions or Sega Dreamcast systems. Product covered under one or more of the following U.S. Patents: 5,460,374; 5,525,770; 5,627,895; 5,688,173; 4,442,486; 4,454,594; 4,462,076; Re. 35,839; Japanese Patent No.2870538, (Patents pending in U.S. and other countries); Canada Patent No. 1,183,276. The ratings icon is a trademark of the Interactive Digital Software Association.



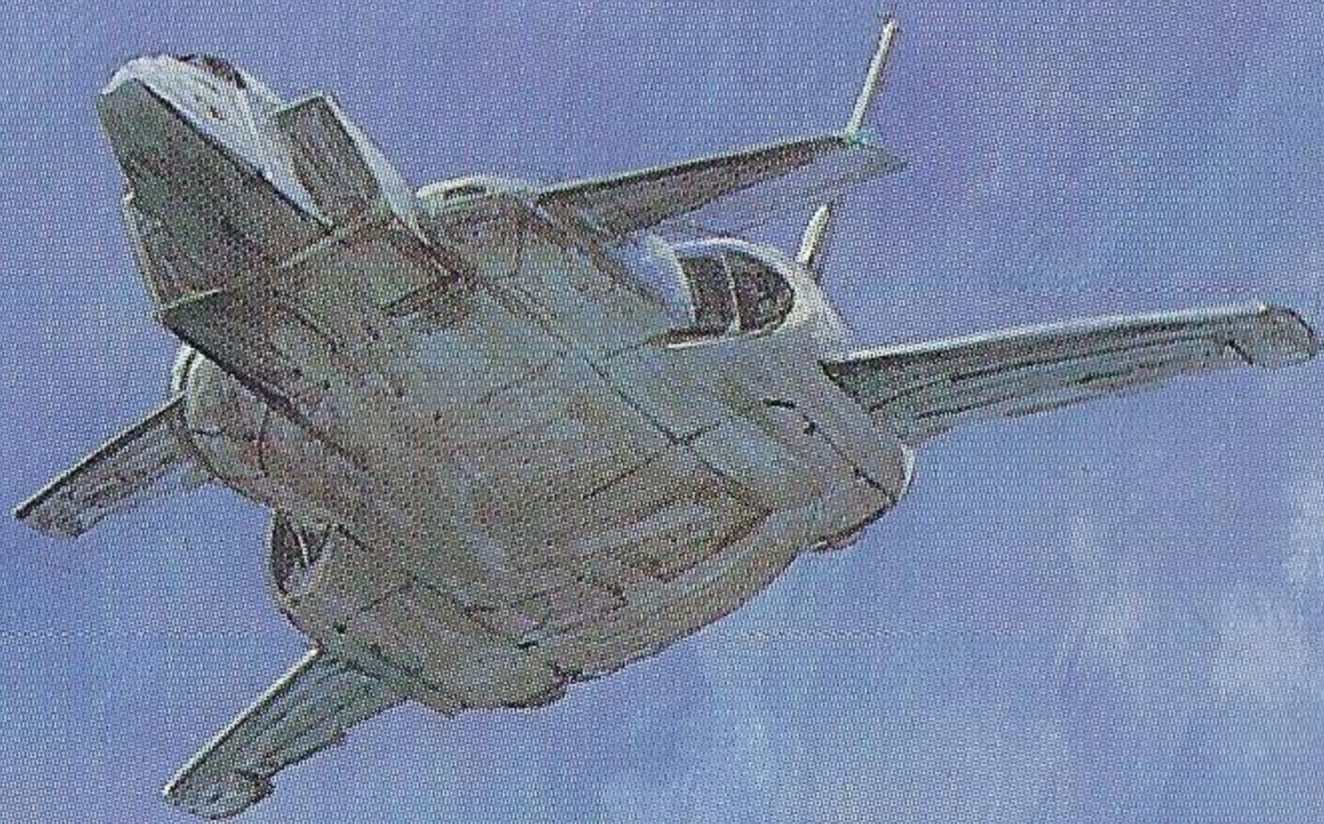

© SOTSU AGENCY • SUNRISE. © 1999 Bandai Co., Ltd.  
Distributed by Bandai America, Incorporated, 5551 Katella Avenue,  
Cypress, California 90630. All Rights Reserved.

Sega is registered in the US Patent and Trademark Office. Sega Dreamcast, the Dreamcast Swirl, are trademarks of SEGA. Sega of America, P.O. Box 7639, San Francisco, CA 94120. All Rights Reserved. Programmed in Japan. Made and printed in the USA. **WARNING:** Operates only with NTSC televisions and Sega Dreamcast systems purchased in North and South America (except Argentina, Paraguay and Uruguay). Will not operate with any other televisions or Sega Dreamcast systems. Product covered under one or more of the following U.S. Patents: 5,460,374; 5,525,770; 5,627,895; 5,688,173; 4,442,486; 4,454,594; 4,462,076; Re. 35,839; Japanese Patent No.2870538, (Patents pending in U.S. and other countries); Canada Patent No. 1,183,276. The ratings icon is a trademark of the Interactive Digital Software Association.

